

PRODUKTSAMMLUNG
PRODUCT COLLECTION

The logo features the words "LED UP" in a bold, black, sans-serif font. The letters are set against a background of horizontal, multi-colored streaks in shades of blue, red, yellow, and white, creating a sense of motion and energy. The entire logo is enclosed within a thick red rectangular border.

LED UP

frame your
inspiration



BIG LEDUP

- größtes, mobiles LED-Display am Markt

- Material - silber eloxierte Aluminiumprofile, 120 mm Bautiefe mit Aluminiumgussverbindern
- einfacher, werkzeugloser Aufbau dank innovativem Stecksystem
- 76 standard Rahmenformate
 - Sondergrößen verfügbar
- TV-Halter für Monitore (bis 10kg), VESA 200 und 400 als Zubehör
- Beginnend mit einem Startmodul können Rahmen bis zu einer Größe von 500x300cm ausgebaut werden
- Unterschiedliche Aufstellvarianten möglich:
 - Systemverbinder aus Metall - Aufstellformen L-, U-, T-, Kreuz & Sternform
- Kombination mit unbeleuchtetem BIG UP möglich
- ABS-Transportkoffer mit Weichschaumeinlage für maximalen Schutz

- *lightweight, mobile light box display*

- *material - silver anodized aluminum profiles, depth only 120 mm, with aluminum die-cast connectors*
- *easy, tool-less assembly thanks to innovative plug-in system*
- *standard frame sizes*
 - *Custom sizes available*
- *TV holder for monitors (up to 10kg), VESA 200 and 400 as an accessory*
- *Beginning with a start module, frames can be expanded up to a size of 500x300cm*
- *Various Installation options are possible*
 - *System connector made of steel - create various shapes like L-, U-, T-, cross or star shape*
- *Combination with non-illuminated BIG UP is also possible*
- *ABS transport case with soft foam insert for maximum protection*

BIG LED UP



Profildesign / profile design

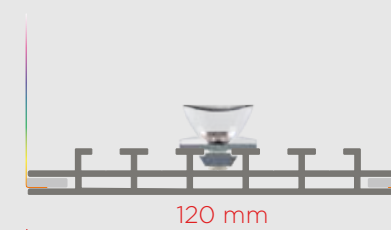

homogene Ausleuchtung dank qualitativ hochwertiger OSRAM LED Technik mit speziell angepasster Linsenform

even lighting using OSRAM LED technique including a specially adapted lens

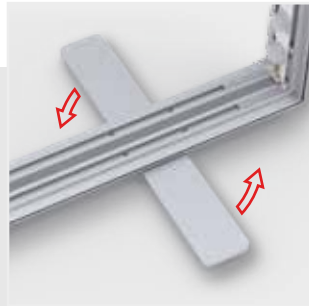

LEDUP

- leichtes, mobiles Leuchtrahmensystem

- Material - silber eloxierte Aluminiumprofile, 80 mm Bautiefe, mit Aluminiumgussverbindern
- 6 standard Rahmenformate 85x200 cm, 85x230 cm, 85x245 cm, 100x200 cm, 100x230 cm und 100x245 cm inkl. ausklappbaren Füßen (Rahmenhöhe +2 cm), nur ca. 9,5 kg Systemgewicht
- endlose Verbindung mehrerer Rahmen möglich
- Verbindungskabel, einfach zum Verstecken. Mit einem Stromanschluss bis zu 10 LEDUPs verbinden
- einfacher, werkzeugloser Aufbau dank innovativem Stecksystem - nur 7 Teile
- Leuchtkraft z.B. H 245 cm ca. 77 Watt, 12600 lm, Farbtemperatur 6500 Kelvin
- Pogo pin Lichttechnik mit hocheffizienten LED Modulen
- umweltfreundliche Kartonverpackung mit Griff und Aufbewahrungskammer für die Stoffpaneele, alternativ auch im ABS Transportkoffer erhältlich

- lightweight, mobile light box display

- material - silver anodized aluminum profiles, depth only 80 mm, with aluminum die-cast connectors
- 6 standard frame sizes 85x200 cm, 85x230 cm, 85x245 cm, 100x200 cm, 100x230 cm and 100x245 cm incl. fold-out bases (frame height +2 cm), only approx. 9,5 kg system weight
- endless connection of several frames possible
- Connection cable, easy to hide. Connect up to 10 LEDUPs to a power connector
- easy, tool-less assembly thanks to innovative plug-in system - only 7 parts
- luminance e.g. H 245 cm approx. 77 Watt, 12600 lm, colour temperature 6500 kelvin
- pogo pin lighting technology with highly efficient LED modules
- eco-friendly cardboard packaging with handle and storage for the fabric panels, alternatively also available with ABS carrying case

LEDUP



OSRAM
LED Technology included

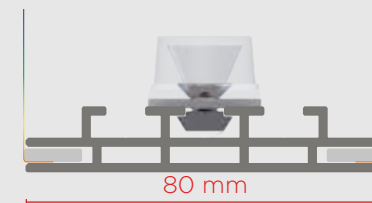

homogene Ausleuchtung dank qualitativ hochwertiger OSRAM LED Technik mit speziell angepasster Linsenform

even lighting using OSRAM LED technique including a specially adapted lens

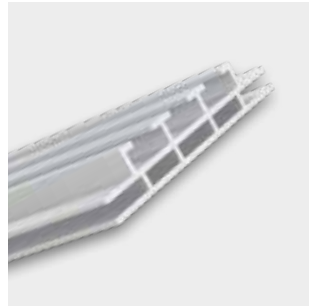

LEDUP BATTERY

- leichtes, mobiles Leuchtrahmensystem mit Lithium - Ionen Akku (10 Stunden)

- Material - silber eloxierte Aluminiumprofile, 80 mm Bautiefe, mit Aluminiumgussverbindern
- Rahmenformat 100x200 cm inkl. ausklappbaren Füßen (Rahmenhöhe +2 cm)
- Pogo pin Lichttechnik mit hocheffizienten LED Modulen - 59 Watt, 12.600 lm, Farbtemperatur 6.500 Kelvin
- Verpackt im ABS Transportkoffer mit Handgriff und leichtgängigen Rollen
- endlose Verbindung mehrerer Rahmen möglich
- einfacher, werkzeugloser Aufbau dank innovativem Stecksystem
- inkl. Akku mit 22Ah für eine Leuchtdauer von über 10 Stunden

- light, mobile illuminated frame system with lithium-ion powerpack (10 hours)

- material - silver anodized aluminum profiles, depth only 80 mm, with aluminum die-cast connectors
- frame size 100x200 cm incl. fold-out bases (frame height +2 cm)
- pogo pin lighting technology with highly efficient LED modules - approx. 59 Watt, 12.600 lm, color temperature 6.500 kelvin
- packed in an ABS transport case with handle and smooth-running wheels
- endless connection of several frames possible
- easy, tool-less assembly thanks to innovative plug-in system
- incl. powerpack with 22Ah for a lighting time of over 10 hours

Wiederaufladbarer 24 Volt Lithium - Ionen Akku
/rechargeable 24 volt lithium-ion powerpack



LEDUP BATTERY

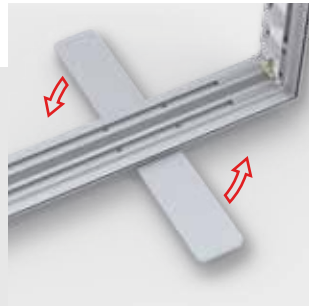

LEDUP Sanitizer

- mobiles Leuchtrahmensystem mit Desinfektionsmittelspender

- Material - silber eloxierte Aluminiumprofile, 80 mm Bautiefe, mit Aluminiumgussverbindern
- 4 standard Rahmenformate 85x146,5 cm, 85x200 cm und 100x146,5 cm, 100x200 cm inkl. ausklappbaren Füßen (Rahmenhöhe +2 cm), nur ca. 9,5 kg Systemgewicht
- berührungsloser Händedesinfektionsmittelspender aus Edelstahl (Unterkante 120 cm) mit einer Füllmenge von 600 ml
- einfacher, werkzeugloser Aufbau dank innovativem Stecksystem - nur 7 Teile
- Farbtemperatur 6500 Kelvin
- Plug & Play Lichttechnik mit hocheffizienten OSRAM LED Modulen
- umweltfreundliche Kartonverpackung mit Griff und Aufbewahrungskammer für die Stoffpaneele, alternativ auch im ABS Transportkoffer erhältlich

- mobile light box display with hand sanitizer dispenser

- material - silver anodized aluminium profiles, depth only 80 mm with aluminium die-cast connectors
- 4 standard frame sizes 85x146,5 cm, 85x200 cm und 100x146,5 cm, 100x200 cm incl. fold-out bases (frame height +2 cm), only approx. 9,5 kg system weight
- touchless hand sanitizer dispenser made of stainless steel (lower edge 120 cm) with a capacity of 600 ml
- easy, tool-less assembly thanks to innovative plug-in system - only 7 parts
- colour temperature 6500 kelvin
- plug & play lighting technology with highly efficient OSRAM LED modules
- eco-friendly cardboard packaging with handle and storage for the fabric panels, alternatively also available with ABS carrying case

LEDUP
SANITIZER



Profildesign / profile design

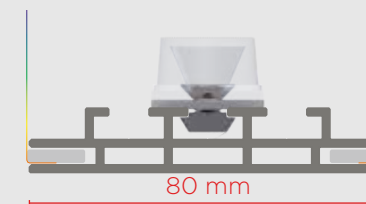

homogene Ausleuchtung dank qualitativ hochwertiger OSRAM LED Technik mit speziell angepasster Linsenform

even lighting using OSRAM LED technique including a specially adapted lens

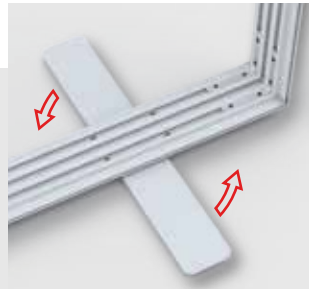

MINI LEDUP

- mobiles Rahmensystem

- Material - silber eloxierte Aluminiumprofile, 80 mm Bautiefe, mit Aluminiumgussverbindern
- standard Rahmenformat 50x150 cm, inkl. ausklappbarem Fuß nur ca. 6,9 kg Systemgewicht
- einfacher, werkzeugloser Aufbau dank innovativem Stecksystem einfacher
- Plug & Play Lichttechnik mit hocheffizienten LED Modulen
- umweltfreundliche Kartonverpackung

- mobile display

- *material - silver anodized aluminium profiles, depth only 80 mm, with aluminium die-cast connectors*
- *standard frame size 50x150 cm incl. fold-out foot, only approx. 6,9 kg system weight*
- *easy, tool-less assembly thanks to innovative plug-in system*
- *plug & play lighting technology with highly efficient LED modules*
- *eco-friendly cardboard packaging*

MINI LEDUP

OSRAM
LED Technology included

Profildesign / profile design

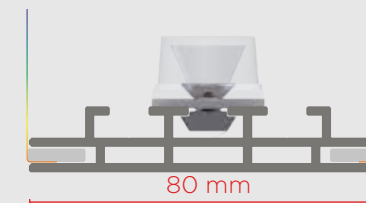

homogene Ausleuchtung dank qualitativ hochwertiger OSRAM LED Technik mit speziell angepasster Linsenform

even lighting using OSRAM LED technique including a specially adapted lens

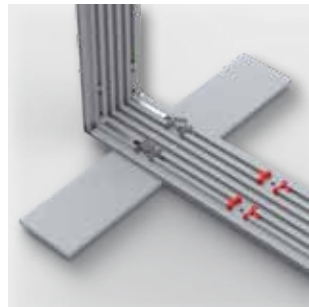
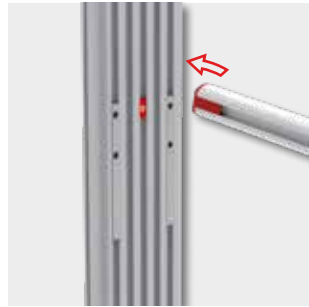
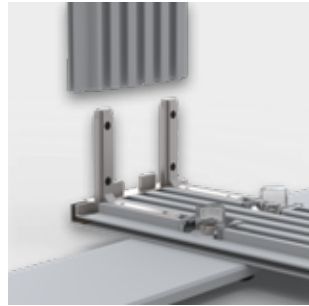

BIG UP

- mobiles Rahmensystem in mehr als 2 Mio. Aufstellgrößen erhältlich

- Material - silber eloxierte Aluminiumprofile, 120 mm Bautiefe, mit Aluminiumgussverbindern
- 12 standard Rahmenformate:
200x200/248/298 cm, 300x200/248/298 cm, 400x200/248/298 cm, 500x200/248/298 cm
- Sondergrößen - Millimeter genau nach Kundenwunsch in Standardlieferzeit auslieferbar
- einfacher, werkzeugloser Aufbau dank innovativem Stecksystem
- Systemverbinder aus Metall - Aufstellformen L-, U-, T-, Kreuz & Sternform
- Kombination mit BIG LEDUP möglich
- ABS-Transportkoffer mit Weichschaumeinlage für maximalen Schutz

- mobile frame system available in more than 2 million installation sizes

- material - silver anodized aluminium profiles, depth only 120 mm, with aluminium die-cast connectors
- 12 standard frame sizes:
200x200/248/298 cm, 300x200/248/298 cm, 400x200/248/298 cm, 500x200/248/298 cm
- Special sizes - Accurate to the millimeter according to customer requirements
- simple, tool-free assembling thanks to the innovative plug-in system
- System connector made of steel - shapes: L-, U-, T-, cross or star shape
- Combination with BIG LEDUP possible
- ABS transport case with special foam lining for maximum protection

Profildesign / profile design



Material - silber eloxierte Aluminiumprofile mit Stahlverbindereinfache Montage und schneller Motivwechsel

material - silver anodized aluminium profiles with steel connectors easy to assemble and graphics change easily

BIG UP

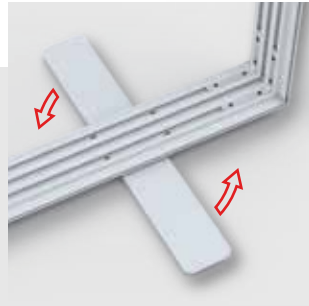
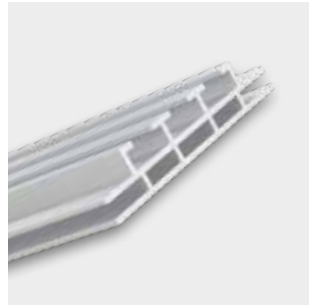

PICUP

- leichtes, mobiles Rahmensystem

- Material - silber eloxierte Aluminiumprofile mit Aluminiumgussverbindern
- 6 standard Rahmenformate:
85x200 cm, 85x230 cm, 85x245 cm, 100x200 cm, 100x230 cm und 100x245 cm
- Bautiefe nur 80 mm
- endlose Verbindung mehrerer Rahmen möglich
- einfacher, werkzeugloser Aufbau dank innovativem Stecksystem - nur 7 Teile
- umweltfreundliche Kartonverpackung mit Griff und Aufbewahrungskammer für die Stoffpaneele
- nur ca. 7,5 kg Systemgewicht

- lightweight, mobile display

- material - silver anodized aluminium profiles with aluminium die-cast connectors
- 6 standard frame sizes:
85x200 cm, 85x230 cm, 85x245 cm, 100x200 cm, 100x230 cm and 100x245 cm,
- depth only 80 mm
- endless connection of several frames possible
- easy, tool-less assembly thanks to innovative plug-in system - only 7 parts
- eco-friendly cardboard packaging with handle and storage for the fabric panels
- only approx. 7,5 kg system weight

PICUP

Profildesign / profile design

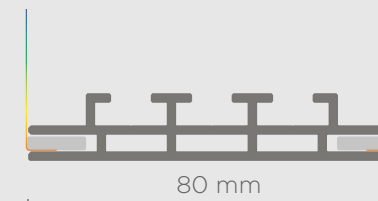

Material - silber eloxierte Aluminiumprofile mit Stahlverbindereinfache Montage und schneller Motivwechsel

material - silver anodized aluminium profiles with steel connectors easy to assemble and graphics change easily

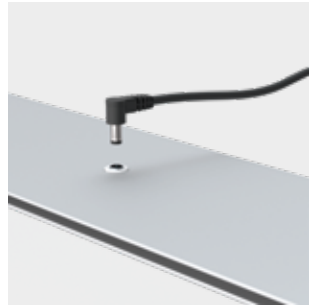
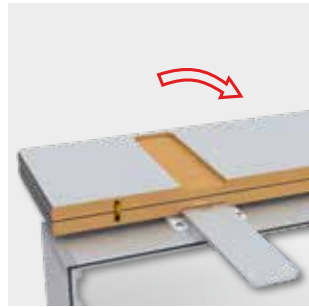
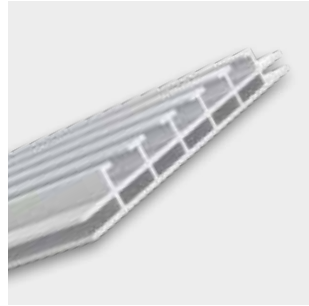

LEDUP COUNTER

- mobiles LED Thekensystem im ABS Transportkoffer

- Material - silber eloxierte Aluminiumprofile 120 mm Bautiefe mit Aluminiumgussverbindern
- beidseitig hinterleuchtet - Rahmenformat 100x100cm
- einfache Montage durch Plug & Play
- homogene Ausleuchtung dank qualitativ hochwertiger OSRAM LED Technik mit speziell angepasster Linsenform
- Leuchtkraft 43 Watt, 5040 lm, Farbtemperatur 6500 Kelvin
- Systemmaße inkl. FüÙe BxHxT 100x104x40 cm
- ABS Transportkoffer BxHxT 118x30x12 cm mit Schaumstoffeinlagen, Rollen und Griff
- ca. 21 kg Transportgewicht (ohne Druck)
- aufklappbare Thekenplatte in schwarz oder silber erhältlich

- mobile LED counter in ABS hardcase

- material - silver anodized aluminium profiles depth 120 mm, with aluminium die-cast connectors
- illuminated on both sides - frame size 100x100 cm
- easy installation because of plug & play
- even lighting illumination - using OSRAM LED technique including a specially adapted lens
- luminance 43 Watt, 5040 lm, colour temperature 6500 Kelvin
- system dimensions incl. bases WxHxD 100x104x40 cm
- ABS hardcase WxHxD 118x30x12 cm with special foam lining, wheels and handle
- approx. 21 kg transport weight (prints not included)
- foldable counter top in black or silver available

LEDUP COUNTER

OSRAM
LED Technology included

Profildesign / profile design

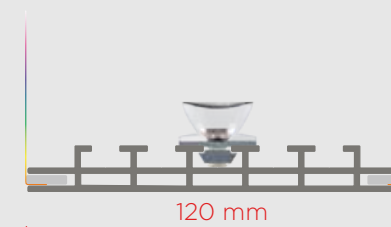

homogene Ausleuchtung dank qualitativ hochwertiger OSRAM LED Technik mit speziell angepasster Linsenform

even lighting using OSRAM LED technique including a specially adapted lens

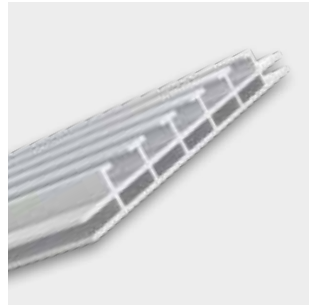

COUNTER ONE

COUNTER ONE

- mobiles LED Thekensystem in ABS Transportkoffer

- beleuchtete Front - Rahmenformat 100x100cm
- einfache Montage dank Plug & Play Lichttechnik
- homogene Ausleuchtung dank qualitativ hochwertiger OSRAM LED Technik mit speziell angepasster Linsenform
- inkl. Zwischenfach und schwarzer Deckplatte
- Systemmaße inkl. Füße BxHxT 100x101,5x48 cm
- ABS Transportkoffer BxHxT 39x30x116 cm mit Schaumstoffeinlagen, Rollen und Griff
- ca. 30 kg Transportgewicht
- optionales Zubehör: wiederaufladbare Lithium - Ionen Akku mit 9 h Leuchtdauer

- mobile LED counter in ABS hardcase

- illuminated front - frame size 100x100 cm
- easy installation thanks to plug & play lighting technology
- even lighting illumination - using OSRAM LED technique including a specially adapted lens
- incl. shelf and black counter top
- system dimensions incl. bases WxHxD 100x101,5x48 cm
- ABS hardcase WxHxD 39x30x116 cm with special foam lining, wheels and handle
- approx. 30 kg transport weight
- optional accessories: rechargeable lithium - ion powerpack with 9 hours illumination

Profildesign / profile design

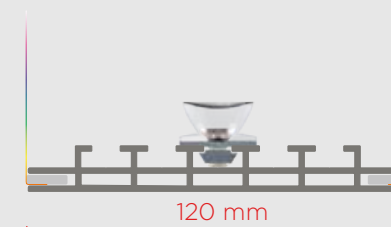

homogene Ausleuchtung dank qualitativ hochwertiger OSRAM LED Technik mit speziell angepasster Linsenform

even lighting using OSRAM LED technique including a specially adapted lens

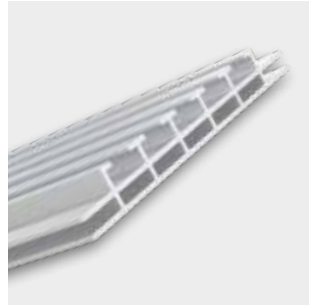

COUNTER MAX

- mobiles LED Thekensystem im ABS Transportkoffer

- beleuchtete Front - Rahmenformat 100x116 cm
- einfache Montage dank Plug & Play Lichttechnik
- homogene Ausleuchtung dank qualitativ hochwertiger OSRAM LED Technik mit speziell angepasster Linsenform
- inkl. Zwischenfach und schwarzer Deckplatte
- Systemmaße inkl. Füße BxHxT 100x118x40 cm
- ABS Transportkoffer BxHxT 40x119x31cm mit Schaumstoffeinlagen, Rollen und Griff
- ca. 30 kg Transportgewicht
- optionales Zubehör: wiederaufladbare Lithium - Ionen Akku mit 9 h Leuchtdauer

- mobile LED counter in ABS hardcase

- illuminated front - frame size 100x116 cm
- easy installation thanks to plug & play lighting technology
- even lighting illumination - using OSRAM LED technique including a specially adapted lens
- incl. shelf and black counter top
- system dimensions incl. bases WxHxD 100x118x40 cm
- ABS hardcase WxHxD 40x119x31 cm with special foam lining, wheels and handle
- approx. 30 kg transport weight
- optional accessories: rechargeable lithium - ion powerpack with 9 hours illumination

COUNTER MAX



Profildesign / profile design

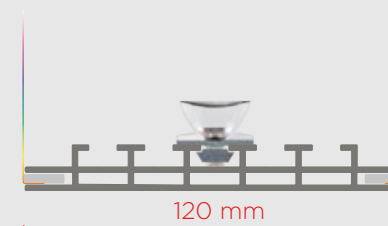

homogene Ausleuchtung dank qualitativ hochwertiger OSRAM LED Technik mit speziell angepasster Linsenform

even lighting using OSRAM LED technique including a specially adapted lens

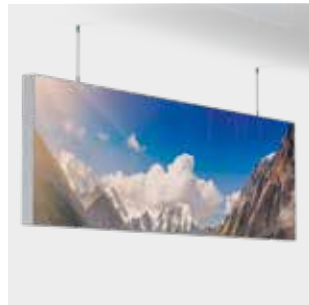

Sonderrahmenbau *custom frame construction*

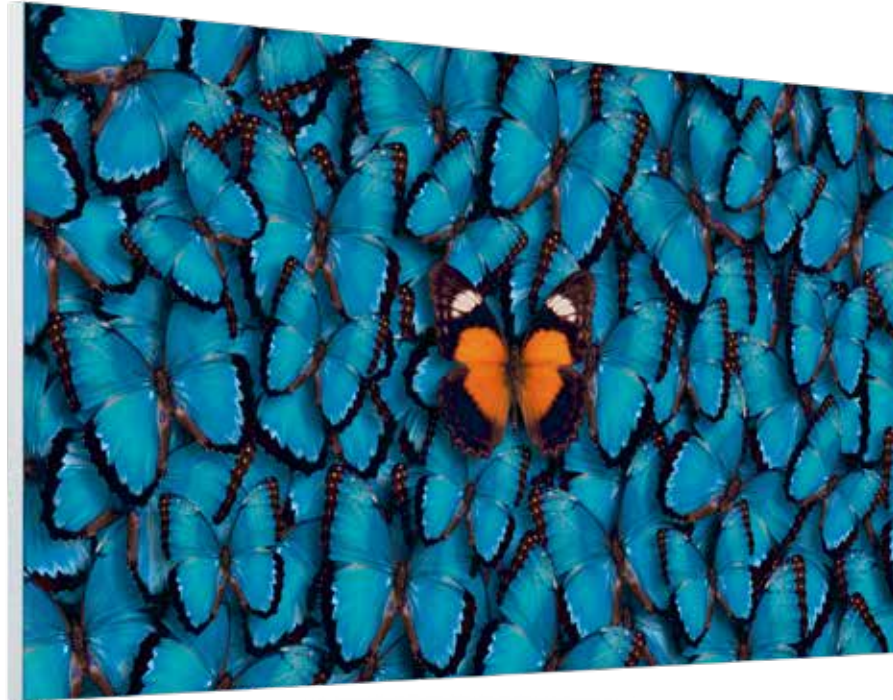

MULTIFRAME

- Sonderformate nach individuellem Kundenwunsch

- Individuell angepasste Rahmengrößen
- Produktionszeit eine Woche + Versandtage
- Beleuchtet oder unbeleuchtet
- Wand- Deckenmontagen, abgehängt oder Freistehend
- Sonderformen möglich
- Verschiedenste Profiltiefen je nach Anwendungsbedarf sind lagernd

- *Special formats according to individual customer requirements*

- *Individually adapted frame sizes*
- *Production time: one week + shipping days*
- *Illuminated or not illuminated*
- *Wall-ceiling mounting, suspended or free-standing*
- *Custom shapes possible*
- *Depending on the application, different profile depths are available*

MULTIframe

OSRAM
LED Technology included

BASIC

SUPER SLIM

SIDE LIGHT

